

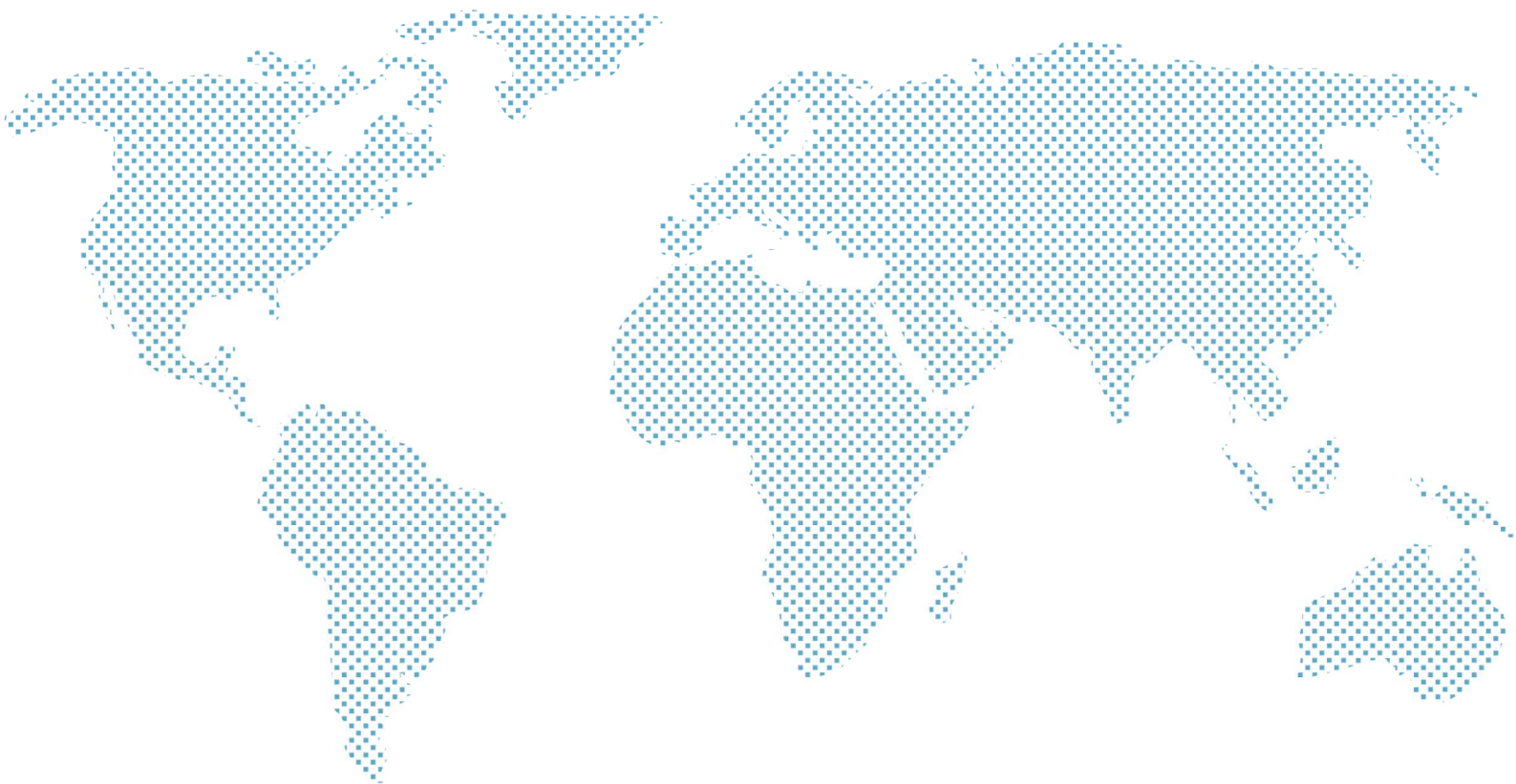

Comef



MEDICAL COMPONENTS

2024
CATALOG

SPIKES AND ACCESSORIES

Page 5

CONNECTORS AND CAPS

Page 11

CLAMPS AND ROLLER CLAMPS

Page 25

INJECTION SITES

Page 29

PILLOWS

Page 37

DRIP CHAMBERS AND ACCESSORIES

Page 39

TRANSDUCER PROTECTORS

Page 55

ACCESSORIES

Page 59

STANDARD PACKINGS

Page 61



Comef

1 WAY ASSEMBLED SPIKES

female Luer lock

ISO 80369-7

Gamma / Beta / EtO sterilization

CODE	MATERIAL	COLOR
36909900SM	SPIKE ABS	WHITE
	CAP LDPE	NEUTRAL

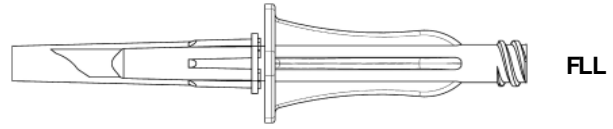

tube seat ID4,8

Gamma / Beta / EtO sterilization

CODE	MATERIAL	COLOR
A036959900	SPIKE ABS	WHITE
	CAP LDPE	NEUTRAL

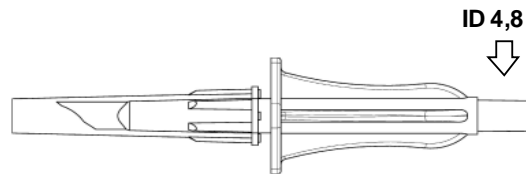

2 WAYS ASSEMBLED SPIKES

female Luer lock

Gamma / Beta / EtO sterilization

CODE	MATERIAL	COLOR	INFO
28609900SM A	SPIKE ABS	WHITE	
	CAP LDPE	NEUTRAL	
	AIR FILTER PP	BLUE	3µm
28679900SM A	SPIKE ABS	WHITE	
	CAP LDPE	NEUTRAL	
	AIR FILTER PP	WHITE	1,2µm
28659900SM B	SPIKE ABS	WHITE	
	CAP LDPE	NEUTRAL	
	AIR FILTER PP	BLUE	3µm
	CAP HDPE	NEUTRAL	

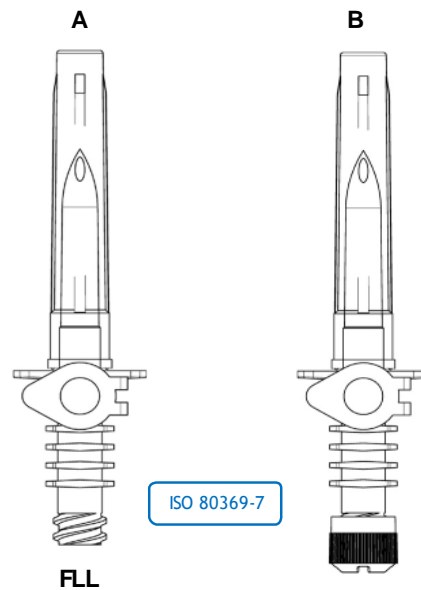

2 WAYS ASSEMBLED SPIKES

for tube OD 4,1 or ID 4,8

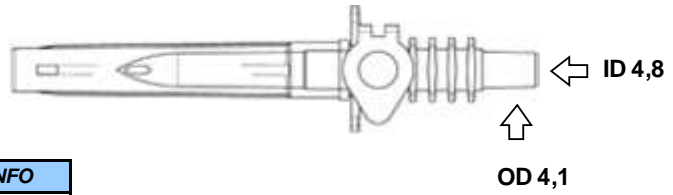

Gamma / Beta / EtO sterilization

CODE	MATERIAL	COLOR	INFO
28709900SM	SPIKE ABS	WHITE	
	CAP LDPE	NEUTRAL	
	AIR FILTER PP	BLUE	3µm
28719900SM	SPIKE ABS	WHITE	
	CAP LDPE	NEUTRAL	
	AIR FILTER PP	WHITE	1,2µm

1 WAY SPIKES

female Luer lock

ISO 80369-7

Gamma / Beta / EtO sterilization

CODE	MATERIAL	COLOR
37018403	ABS	WHITE

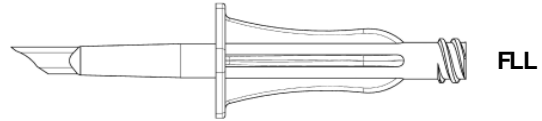

for tube ID 4,8

Gamma / Beta / EtO sterilization

CODE	MATERIAL	COLOR
37028403	ABS	WHITE

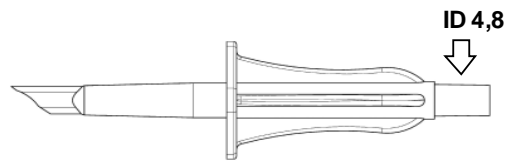

for tube ID 4,8 / OD 4,8

Gamma / Beta / EtO sterilization

CODE	MATERIAL	COLOR
18808403	ABS	WHITE

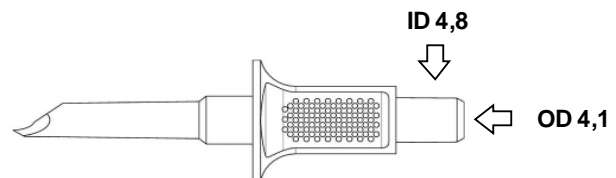

for tube OD 5,5

Gamma / Beta / EtO sterilization

CODE	MATERIAL	COLOR
18708403	ABS	WHITE

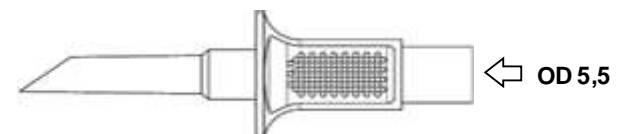

2 WAYS SPIKES

female Luer lock

ISO 80369-7

Gamma / Beta / EtO sterilization

CODE	MATERIAL	COLOR
22708403	ABS	WHITE

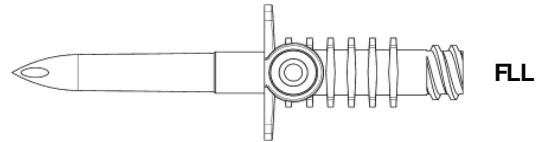

for tube OD 4,1 or ID 4,8

Gamma / Beta / EtO sterilization

CODE	MATERIAL	COLOR
22808403	ABS	WHITE

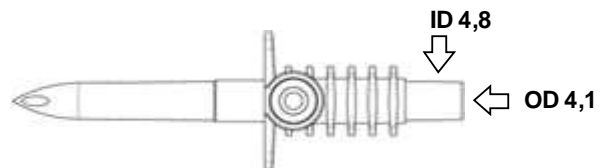

SPIKES FOR CHAMBER

1 way

Gamma / Beta / EtO sterilization

CODE	MATERIAL	COLOR	DROPS
13608403	ABS	WHITE	20

EtO sterilization

CODE	MATERIAL	COLOR	DROPS
13608103	RIGID PVC	WHITE	20

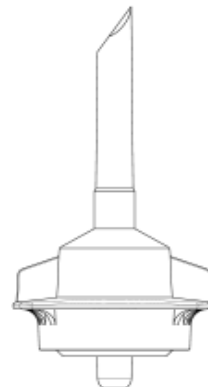

VENTED CAPS FOR SPIKES

Gamma / Beta / EtO sterilization

CODE	MATERIAL	COLOR
25818200	LLDPE	NEUTRAL

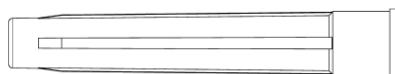

CODE	MATERIAL	COLOR
31108200	LLDPE	NEUTRAL



CODE	MATERIAL	COLOR
18908200	LDPE	NEUTRAL



AIR INLET FILTERS

Gamma / Beta / EtO sterilization

CODE	MATERIAL	COLOR	INFO
11508303	PP	WHITE	3µm
11508308	PP	LIGHT BLUE	3µm
11808303	PP	WHITE	1,2µm

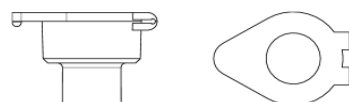



Comef

ROTATING MALE LUER LOCK

self ejecting

ISO 80369-7

MLL

Gamma / Beta / EtO sterilization

CODE	MATERIAL		COLOR	TUBING
A048209300	BODY RIGID PVC	RING MABS	NEUTRAL	OD6,8
A048209301	BODY RIGID PVC	RING MABS	RED	OD6,8
A048209302	BODY RIGID PVC	RING MABS	BLUE	OD6,8
A048229300	BODY RIGID PVC	RING MABS	NEUTRAL	OD5,5
A048229301	BODY RIGID PVC	RING MABS	RED	OD5,5
A048229302	BODY RIGID PVC	RING MABS	BLUE	OD5,5
A048239300	BODY RIGID PVC	RING MABS	NEUTRAL	OD4,1

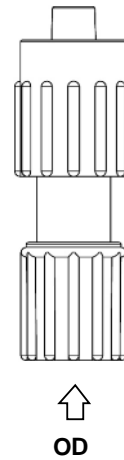

EtO sterilization

CODE	MATERIAL		COLOR	TUBING
A048209900	BODY RIGID PVC	RING MABS	NEUTRAL	OD6,8
A048209901	BODY RIGID PVC	RING MABS	RED	OD6,8
A048209902	BODY RIGID PVC	RING MABS	BLUE	OD6,8
A048229900	BODY RIGID PVC	RING MABS	NEUTRAL	OD5,5
A048229901	BODY RIGID PVC	RING MABS	RED	OD5,5
A048229902	BODY RIGID PVC	RING MABS	BLUE	OD5,5
A048239900	BODY RIGID PVC	RING MABS	NEUTRAL	OD4,1

CAPS FOR ROTATING MALE LUER LOCK

Gamma / Beta / EtO sterilization

CODE	MATERIAL	COLOR	INFO
34608200	LDPE	NEUTRAL	VENTED
34608201	LDPE	RED	VENTED
34608202	LDPE	BLUE	VENTED

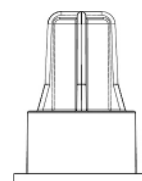

LUER CONNECTORS

female Luer lock

Gamma / Beta / EtO sterilization

CODE	MATERIAL	COLOR	TUBING
C045415100	RIGID PVC	NEUTRAL	OD5,5

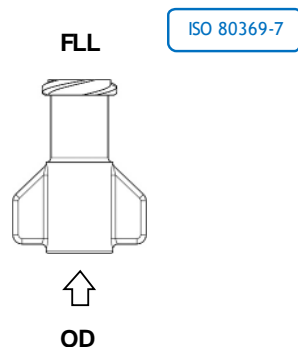

CODE	MATERIAL	COLOR	TUBING
26905100	RIGID PVC	NEUTRAL	OD5,5
26908400	MABS	NEUTRAL	OD5,5
C026955100	RIGID PVC	NEUTRAL	OD5
C026958400	MABS	NEUTRAL	OD5
26935100	RIGID PVC	NEUTRAL	OD4,1
26938400	MABS	NEUTRAL	OD4,1
26925100	RIGID PVC	NEUTRAL	OD2,5
26915100	RIGID PVC	NEUTRAL	OD2



LUER CONNECTORS

female Luer lock

EtO sterilization

CODE	MATERIAL	COLOR	TUBING
C045418100	RIGID PVC	NEUTRAL	OD5,5

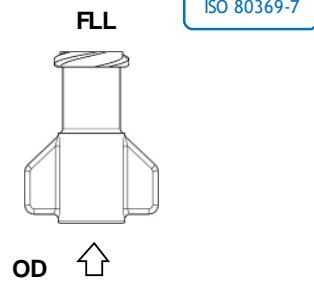

CODE	MATERIAL	COLOR	TUBING
26908100	RIGID PVC	NEUTRAL	OD5,5
C026958100	RIGID PVC	NEUTRAL	OD5
26938100	RIGID PVC	NEUTRAL	OD4,1
26928100	RIGID PVC	NEUTRAL	OD2,5
26918100	RIGID PVC	NEUTRAL	OD2



CODE	MATERIAL	COLOR	TUBING
32158100	RIGID PVC	NEUTRAL	ID3,5
32158400	MABS	NEUTRAL	ID3,5
32138100	RIGID PVC	NEUTRAL	OD3 OR ID3,5
32128100	RIGID PVC	NEUTRAL	OD2,5 OR ID3,5
32128103	RIGID PVC	WHITE	OD2,5 OR ID3,5
32128107	RIGID PVC	YELLOW	OD2,5 OR ID3,5

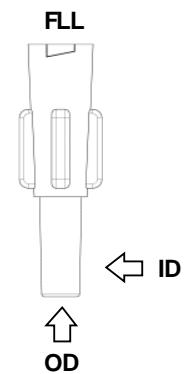

LUER CONNECTORS

male Luer lock

Gamma / Beta / EtO sterilization

CODE	MATERIAL	COLOR	TUBING
34555100	RIGID PVC	NEUTRAL	OD5,5
34558400	MABS	NEUTRAL	OD5,5
34525100	RIGID PVC	NEUTRAL	OD5
34528400	MABS	NEUTRAL	OD5
34505100	RIGID PVC	NEUTRAL	OD4,1 OR ID4,8
34508400	MABS	NEUTRAL	OD4,1 OR ID4,8
34515100	RIGID PVC	NEUTRAL	ID3,5
34518400	MABS	NEUTRAL	ID3,5

CODE	MATERIAL	COLOR	TUBING
33905100	RIGID PVC	NEUTRAL	OD3

EtO sterilization

CODE	MATERIAL	COLOR	TUBING
34558100	RIGID PVC	NEUTRAL	OD5,5
34528100	RIGID PVC	NEUTRAL	OD5
34508100	RIGID PVC	NEUTRAL	OD4,1 OR ID4,8
34518100	RIGID PVC	NEUTRAL	ID3,5

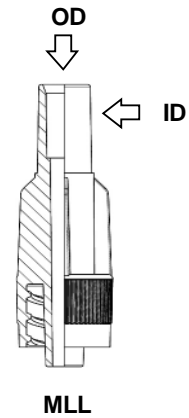
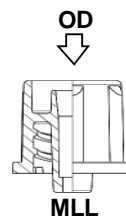
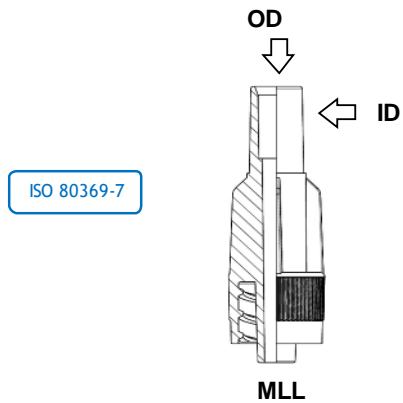

LUER CONNECTORS

male Luer lock

EtO sterilization

CODE	MATERIAL	COLOR	TUBING
33908100	RIGID PVC	NEUTRAL	OD3
33808100	RIGID PVC	NEUTRAL	OD2,5

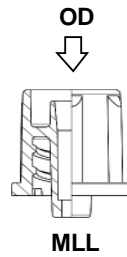

CODE	MATERIAL	COLOR	TUBING
45908100	RIGID PVC	NEUTRAL	OD4,1 OR ID4,8
45928100	RIGID PVC	NEUTRAL	ID3,5
45918100	RIGID PVC	NEUTRAL	ID4,8

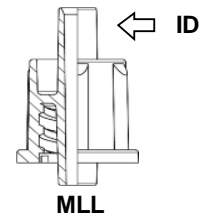

male Luer

EtO sterilization

CODE	MATERIAL	COLOR
C002908100	RIGID PVC	NEUTRAL
C002908101	RIGID PVC	RED
C002908102	RIGID PVC	BLUE

ISO 80369-7

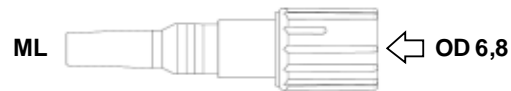

double male Luer

Gamma / Beta / EtO sterilization

CODE	MATERIAL	COLOR
02708403	ABS	WHITE

ISO 80369-7

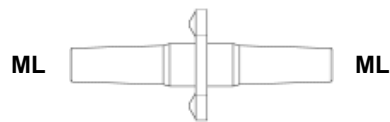

EtO sterilization

CODE	MATERIAL	COLOR
02708100	RIGID PVC	NEUTRAL

LUER CAPS

male Luer lock

Gamma / Beta / EtO sterilization

CODE	MATERIAL	COLOR
33618207	HDPE	YELLOW

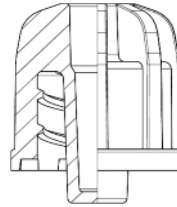

CODE	MATERIAL	COLOR
34418200	HDPE	NEUTRAL
34418403	ABS	WHITE

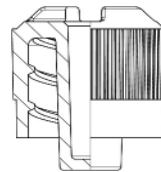

ISO 80369-7

CODE	MATERIAL	COLOR
C033408403	ABS	WHITE

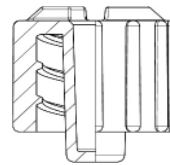

ISO 80369-7

LUER CAPS

female Luer lock

Gamma / Beta / EtO / Steam sterilization

CODE	MATERIAL	COLOR	INFO
39808300	PP	NEUTRAL	CLOSED

Gamma / Beta / EtO sterilization

CODE	MATERIAL	COLOR	INFO
39808200	HDPE	NEUTRAL	CLOSED
39808201	HDPE	RED	CLOSED
39808202	HDPE	BLUE	CLOSED

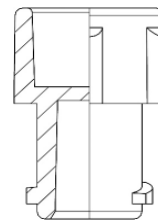

39818200	LDPE	NEUTRAL	VENTED
39818201	LDPE	RED	VENTED
39818202	LDPE	BLUE	VENTED
39818207	LDPE	YELLOW	VENTED

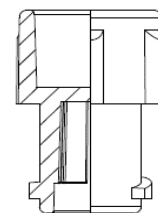

LUER CAPS

male Luer lock with collar



Gamma / Beta / EtO sterilization

CODE	MATERIAL	COLOR
36608200	LDPE	NEUTRAL

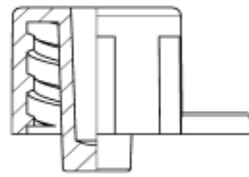

female Luer

Gamma / Beta / EtO sterilization

CODE	MATERIAL	COLOR	INFO
02808203	LDPE	WHITE	VENTED

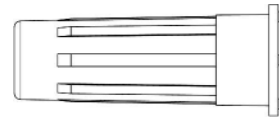

EtO sterilization

CODE	MATERIAL	COLOR	INFO
08508200	LDPE	NEUTRAL	VENTED



"T" CONNECTORS

with service line for tube

Gamma / Beta / EtO sterilization

CODE	MATERIAL	COLOR	OD	TUBING
01845100	RIGID PVC	NEUTRAL	6,8	OD5,5

EtO sterilization

CODE	MATERIAL	COLOR	OD	TUBING
01848100	RIGID PVC	NEUTRAL	6,8	OD5,5

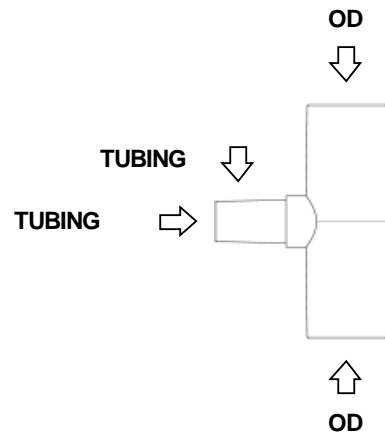

with service line female Luer lock

EtO sterilization

CODE	MATERIAL	COLOR
14608100	RIGID PVC	NEUTRAL

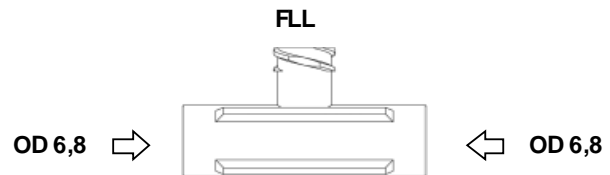

"Y" CONNECTORS

2 + 1 ways

Gamma / Beta / EtO sterilization

CODE	MATERIAL	COLOR	OD
148380N0	SOFT PVC DEHP FREE	NEUTRAL	6,8
103380N0	SOFT PVC DEHP FREE	NEUTRAL	5,5
102380N0	SOFT PVC DEHP FREE	NEUTRAL	4,1

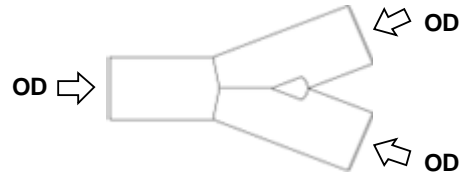

CODE	MATERIAL	COLOR	OD
10607500	SOFT PVC DEHP FREE	NEUTRAL	5,5
152080N0	SOFT PVC DEHP FREE	NEUTRAL	4,1

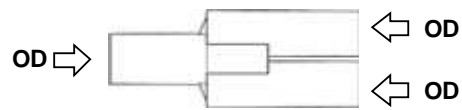

"W" CONNECTORS

3 + 1 ways

Gamma / Beta / EtO sterilization

CODE	MATERIAL	COLOR
105080N0	SOFT PVC DEHP FREE	NEUTRAL

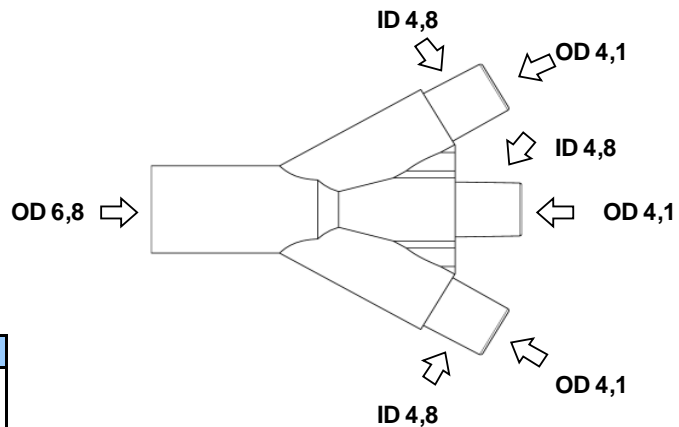
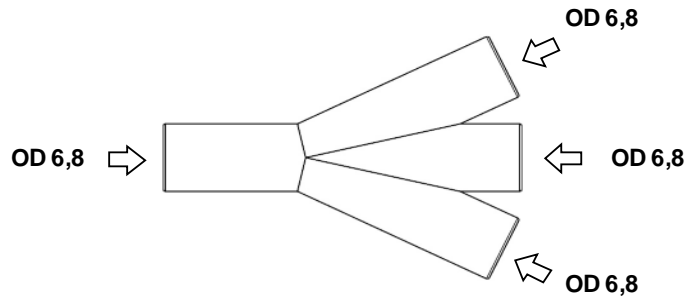

EtO sterilization

CODE	MATERIAL	COLOR
11408100	RIGID PVC	NEUTRAL

PUMP CONNECTORS

for tube OD 9,54

Gamma / Beta / EtO sterilization

CODE	MATERIAL	COLOR
47107500	SOFT PVC DEHP FREE	NEUTRAL

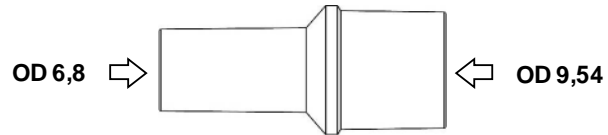

for tube OD 9,54 and service line

Gamma / Beta / EtO sterilization

CODE	MATERIAL	COLOR	OD
47137500	SOFT PVC DEHP FREE	NEUTRAL	5,5
47127500	SOFT PVC DEHP FREE	NEUTRAL	2,5
47117500	SOFT PVC DEHP FREE	NEUTRAL	2

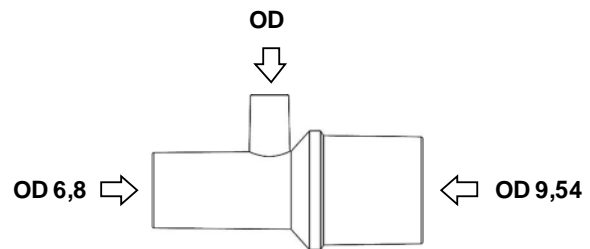

for tube OD 12

Gamma / Beta / EtO sterilization

CODE	MATERIAL	COLOR
C027307500	SOFT PVC DEHP FREE	NEUTRAL

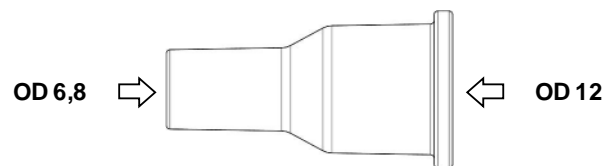

for tube OD 12 and service line

Gamma / Beta / EtO sterilization

CODE	MATERIAL	COLOR	OD
C027337500	SOFT PVC DEHP FREE	NEUTRAL	5,5
C027347500	SOFT PVC DEHP FREE	NEUTRAL	4,1
C027327500	SOFT PVC DEHP FREE	NEUTRAL	2,5
C027317500	SOFT PVC DEHP FREE	NEUTRAL	2

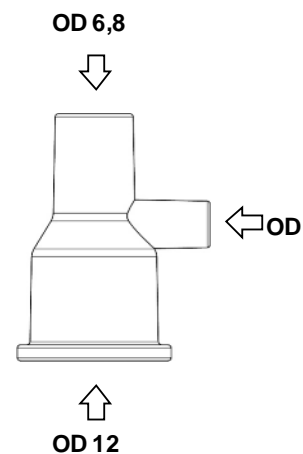

PUMP CONNECTORS

for silicone tube

EtO sterilization

CODE	MATERIAL	COLOR	ID	TUBING
13108100	RIGID PVC	NEUTRAL	8	OD6,8
13108101	RIGID PVC	RED	8	OD6,8
13108102	RIGID PVC	BLUE	8	OD6,8
15608100	RIGID PVC	NEUTRAL	6,36	OD6,8
15608101	RIGID PVC	RED	6,36	OD6,8
15608102	RIGID PVC	BLUE	6,36	OD6,8
15508100	RIGID PVC	NEUTRAL	4,8	OD6,8
15908100	RIGID PVC	NEUTRAL	4,8	OD5,5

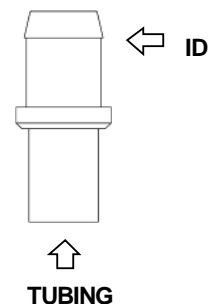

CODE	MATERIAL	COLOR	ID	TUBING
41908100	RIGID PVC	NEUTRAL	4	ID3

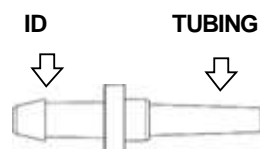

PUMP CONNECTORS

for tube ID 6,36

Gamma / Beta / EtO sterilization

CODE	MATERIAL	COLOR
15708100	RIGID PVC	NEUTRAL

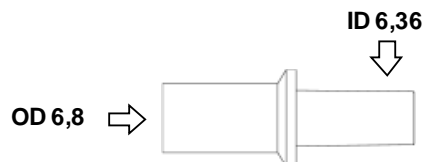

"Y" PUMP CONNECTORS

for tube OD 9,54

Gamma / Beta / EtO sterilization

CODE	MATERIAL	COLOR
15017500	SOFT PVC DEHP FREE	NEUTRAL

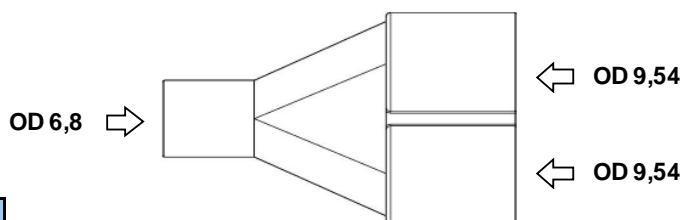

DIALYSER CONNECTORS

female

Gamma / Beta / EtO sterilization

CODE	MATERIAL	COLOR	OD
26807500	SOFT PVC DEHP FREE	NEUTRAL	6,8
26807501	SOFT PVC DEHP FREE	RED	6,8
26807502	SOFT PVC DEHP FREE	BLUE	6,8
26806701	SEMIR. PVC DEHP FREE	RED	6,8
26806702	SEMIR. PVC DEHP FREE	BLUE	6,8
26827500	SOFT PVC DEHP FREE	NEUTRAL	6,5
26817500	SOFT PVC DEHP FREE	NEUTRAL	5,5
26817501	SOFT PVC DEHP FREE	RED	5,5
26817502	SOFT PVC DEHP FREE	BLUE	5,5
26816701	SEMIR. PVC DEHP FREE	RED	5,5
26816702	SEMIR. PVC DEHP FREE	BLUE	5,5

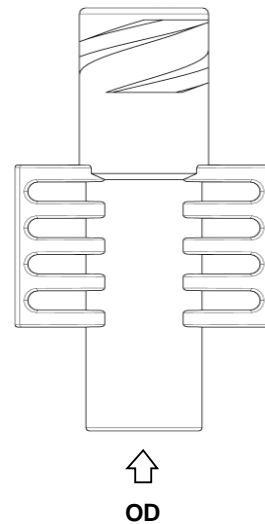

CAPS FOR DIALYSER CONNECTORS

male lock

Gamma / Beta / EtO / Steam sterilization

CODE	MATERIAL	COLOR	INFO
27078300	PP	NEUTRAL	CLOSED
27078301	PP	RED	CLOSED

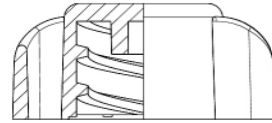

male

Gamma / Beta / EtO sterilization

CODE	MATERIAL	COLOR	INFO
32408200	LDPE	NEUTRAL	CLOSED
32408201	LDPE	RED	CLOSED
32408202	LDPE	BLUE	CLOSED
32808200	LDPE	NEUTRAL	VENTED
32808201	LDPE	RED	VENTED
32808202	LDPE	BLUE	VENTED
32808203	LDPE	WHITE	VENTED

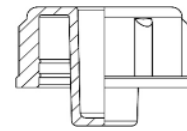

32918200	HDPE	NEUTRAL	CLOSED
32918201	HDPE	RED	CLOSED
32918202	HDPE	BLUE	CLOSED
33508200	HDPE	NEUTRAL	VENTED
33508201	HDPE	RED	VENTED
33508202	HDPE	BLUE	VENTED

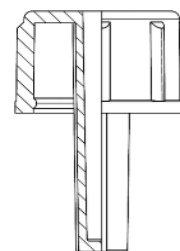

CARDIOSURGICAL CONNECTORS

Gamma / Beta / EtO / Steam sterilization

CODE	MATERIAL	COLOR	FITTING
50208800	PC	NEUTRAL	1/2" 3/8"
50308800	PC	NEUTRAL	2x 3/8"
50608800	PC	NEUTRAL	3/8" 1/4"
51008800	PC	NEUTRAL	1/4" 3/16"

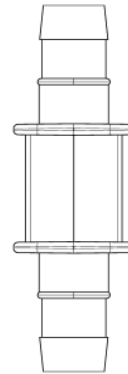

"Y"

Gamma / Beta / EtO / Steam sterilization

CODE	MATERIAL	COLOR	FITTING
49508800	PC	NEUTRAL	3/8" 2x 1/4"
49908800	PC	NEUTRAL	3x 3/16"
50008800	PC	NEUTRAL	1/2" 3/8" 1/2"
50108800	PC	NEUTRAL	1/2" 2x 3/8"
50708800	PC	NEUTRAL	3x 3/8"
50908800	PC	NEUTRAL	3x 1/4"

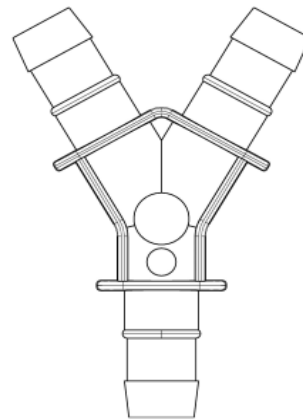

CLAMPS

small, on / off

Gamma / Beta / EtO / Steam sterilization

CODE	MATERIAL	COLOR	TUBING
42608301	PP	RED	3x4,1
42608302	PP	BLUE	3x4,1
42608303	PP	WHITE	3x4,1

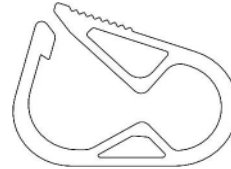

EtO / Steam sterilization

CODE	MATERIAL	COLOR	TUBING
42608900	POM	NEUTRAL	3x4,1

medium, on / off

Gamma / Beta / EtO / Steam sterilization

CODE	MATERIAL	COLOR	TUBING
31228301	PP	RED	3,5x5,5
			4,3x6,8
			4,8x6,8
31228302	PP	BLUE	3,5x5,5
			4,3x6,8
			4,8x6,8
31228303	PP	WHITE	3,5x5,5
			4,3x6,8
			4,8x6,8



CLAMPS

big, on / off

Gamma / Beta / EtO / Steam sterilization

CODE	MATERIAL	COLOR	TUBING
C004708300	PP	NEUTRAL	4,3x6,8 4,8x6,8 6x8
C004708301	PP	RED	4,3x6,8 4,8x6,8 6x8
C004708302	PP	BLUE	4,3x6,8 4,8x6,8 6x8
C004708303	PP	WHITE	4,3x6,8 4,8x6,8 6x8

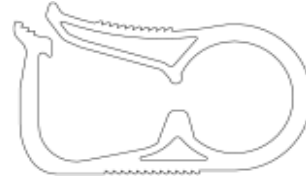

big multi step

Gamma / Beta / EtO / Steam sterilization

CODE	MATERIAL	COLOR	TUBING
38928300	PP	NEUTRAL	3,5x5,5 4,3x6,8 4,8x6,8
38928301	PP	RED	3,5x5,5 4,3x6,8 4,8x6,8
38928302	PP	BLUE	3,5x5,5 4,3x6,8 4,8x6,8
38928303	PP	WHITE	3,5x5,5 4,3x6,8 4,8x6,8



Gamma / Beta / EtO sterilization

CODE	MATERIAL	COLOR	TUBING
38928503	PS	WHITE	3,5x5,5 4,3x6,8 4,8x6,8

EtO / Steam sterilization

CODE	MATERIAL	COLOR	TUBING
38928913	POM	WHITE	3,5x5,5 4,3x6,8 4,8x6,8

SLIDE CLAMPS

medium

Gamma / Beta / EtO sterilization

CODE	MATERIAL	COLOR	TUBING
10908200	HDPE	NEUTRAL	3,5x5,5

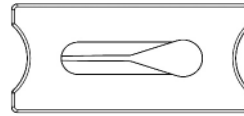

big

Gamma / Beta / EtO sterilization

CODE	MATERIAL	COLOR	TUBING
10808200	HDPE	NEUTRAL	3,5x5,5 4,8x6,8

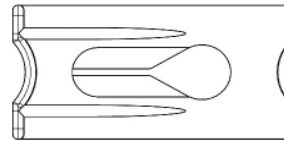

open

EtO sterilization

CODE	MATERIAL	COLOR	TUBING
25008103	RIGID PVC	WHITE	3x4,1

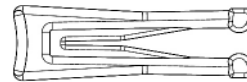

ROLLER CLAMP BODIES

big, for tube 4,8 x 6,8

Gamma / Beta / EtO sterilization

CODE	MATERIAL	COLOR
56408403	ABS	WHITE

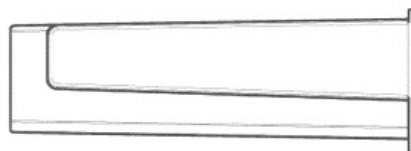

ROLLER CLAMP WHEELS

big, for tube 4,8 x 6,8

Gamma / Beta / EtO sterilization

CODE	MATERIAL	COLOR
56508403	ABS	WHITE



"T" INJECTION SITES LATEX FREE

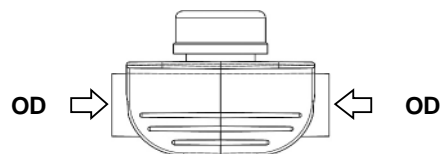

Gamma / Beta / EtO sterilization

CODE	MATERIAL			COLOR	OD
70039200SM	BODY RIGID PVC	COVER PP	PLUG IR	NEUTRAL	6,8
70039201SM	BODY RIGID PVC	COVER PP	PLUG IR	RED	6,8
70039202SM	BODY RIGID PVC	COVER PP	PLUG IR	BLUE	6,8
70049201SM	BODY RIGID PVC	COVER PP	PLUG IR	RED	6,5
70049202SM	BODY RIGID PVC	COVER PP	PLUG IR	BLUE	6,5

EtO sterilization

CODE	MATERIAL			COLOR	OD
70039100SM	BODY RIGID PVC	COVER PP	PLUG IR	NEUTRAL	6,8
70039101SM	BODY RIGID PVC	COVER PP	PLUG IR	RED	6,8
70039102SM	BODY RIGID PVC	COVER PP	PLUG IR	BLUE	6,8
70039103SM	BODY RIGID PVC	COVER PP	PLUG IR	WHITE	6,8
70039105SM	BODY RIGID PVC	COVER PP	PLUG IR	GREEN	6,8
70049101SM	BODY RIGID PVC	COVER PP	PLUG IR	RED	6,5
70049102SM	BODY RIGID PVC	COVER PP	PLUG IR	BLUE	6,5

"T" INJECTION SITES LATEX FREE

with service line

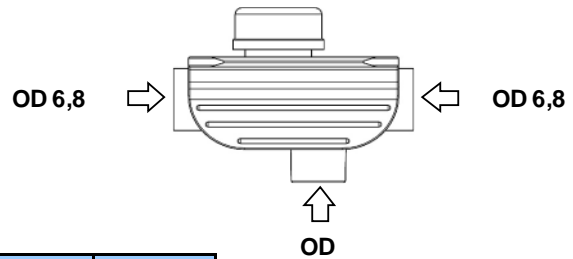

Gamma / Beta / EtO sterilization

CODE	MATERIAL			COLOR	OD
73039200SM	BODY RIGID PVC	COVER PP	PLUG IR	NEUTRAL	5,5
73039201SM	BODY RIGID PVC	COVER PP	PLUG IR	RED	5,5
73039202SM	BODY RIGID PVC	COVER PP	PLUG IR	BLUE	5,5
73059200SM	BODY RIGID PVC	COVER PP	PLUG IR	NEUTRAL	4,1
73059201SM	BODY RIGID PVC	COVER PP	PLUG IR	RED	4,1
73059202SM	BODY RIGID PVC	COVER PP	PLUG IR	BLUE	4,1
73069200SM	BODY RIGID PVC	COVER PP	PLUG IR	NEUTRAL	3
73069201SM	BODY RIGID PVC	COVER PP	PLUG IR	RED	3
73069202SM	BODY RIGID PVC	COVER PP	PLUG IR	BLUE	3
73079200SM	BODY RIGID PVC	COVER PP	PLUG IR	NEUTRAL	2,5
73079201SM	BODY RIGID PVC	COVER PP	PLUG IR	RED	2,5
73079202SM	BODY RIGID PVC	COVER PP	PLUG IR	BLUE	2,5
73089200SM	BODY RIGID PVC	COVER PP	PLUG IR	NEUTRAL	2
73089201SM	BODY RIGID PVC	COVER PP	PLUG IR	RED	2
73089202SM	BODY RIGID PVC	COVER PP	PLUG IR	BLUE	2

EtO sterilization

CODE	MATERIAL			COLOR	OD
73039100SM	BODY RIGID PVC	COVER PP	PLUG IR	NEUTRAL	5,5
73039101SM	BODY RIGID PVC	COVER PP	PLUG IR	RED	5,5
73039102SM	BODY RIGID PVC	COVER PP	PLUG IR	BLUE	5,5
73059100SM	BODY RIGID PVC	COVER PP	PLUG IR	NEUTRAL	4,1
73059101SM	BODY RIGID PVC	COVER PP	PLUG IR	RED	4,1
73059102SM	BODY RIGID PVC	COVER PP	PLUG IR	BLUE	4,1
73069100SM	BODY RIGID PVC	COVER PP	PLUG IR	NEUTRAL	3
73069101SM	BODY RIGID PVC	COVER PP	PLUG IR	RED	3
73069102SM	BODY RIGID PVC	COVER PP	PLUG IR	BLUE	3
73079100SM	BODY RIGID PVC	COVER PP	PLUG IR	NEUTRAL	2,5
73079101SM	BODY RIGID PVC	COVER PP	PLUG IR	RED	2,5
73079102SM	BODY RIGID PVC	COVER PP	PLUG IR	BLUE	2,5
73089100SM	BODY RIGID PVC	COVER PP	PLUG IR	NEUTRAL	2
73089101SM	BODY RIGID PVC	COVER PP	PLUG IR	RED	2
73089102SM	BODY RIGID PVC	COVER PP	PLUG IR	BLUE	2

INJECTION SITES LATEX FREE

male Luer lock

Gamma / Beta / EtO / Steam sterilization

CODE	MATERIAL		COLOR
34709003SM	BODY PC	PLUG IR	WHITE

Gamma / Beta / EtO sterilization

CODE	MATERIAL		COLOR
34709400SM	BODY MABS	PLUG IR	NEUTRAL

EtO sterilization

CODE	MATERIAL		COLOR
34709100SM	BODY RIGID PVC	PLUG IR	NEUTRAL

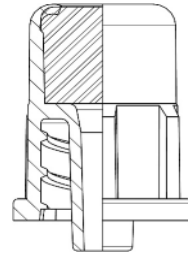

MLL

ISO 80369-7

male Luer

Gamma / Beta / EtO / Steam sterilization

CODE	MATERIAL			COLOR
50079000SM	BODY PC	PLUG IR	CAP PP	NEUTRAL
50079001SM	BODY PC	PLUG IR	CAP PP	RED
50079002SM	BODY PC	PLUG IR	CAP PP	BLUE

EtO sterilization

CODE	MATERIAL			COLOR
50019100SM	BODY RIGID PVC	PLUG IR	CAP PP	NEUTRAL
50019102SM	BODY RIGID PVC	PLUG IR	CAP PP	BLUE

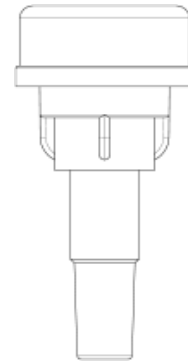

ML

INJECTION SITES LATEX FREE

male Luer and tear cap

Gamma / Beta / EtO / Steam sterilization

CODE	MATERIAL			COLOR
54079000SM	BODY PC	PLUG IR	CAP PP	NEUTRAL
54079008SM	BODY PC	PLUG IR	CAP PP	LIGHT BLUE

EtO sterilization

CODE	MATERIAL			COLOR
54019100SM	BODY RIGID PVC	PLUG IR	CAP PP	NEUTRAL
54019108SM	BODY RIGID PVC	PLUG IR	CAP PP	LIGHT BLUE

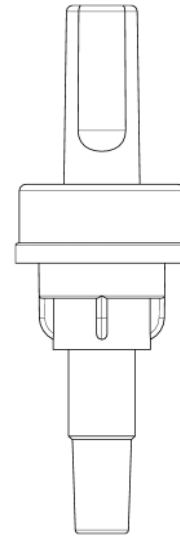

ML

INJECTION SITES LATEX FREE

with tube seat

Gamma / Beta / EtO / Steam sterilization

CODE	MATERIAL			COLOR	TUBING
50179000SM	BODY PC	PLUG IR	CAP PP	NEUTRAL	OD5,5
50179001SM	BODY PC	PLUG IR	CAP PP	RED	OD5,5
50179002SM	BODY PC	PLUG IR	CAP PP	BLUE	OD5,5
50279000SM	BODY PC	PLUG IR	CAP PP	NEUTRAL	ID6
50279001SM	BODY PC	PLUG IR	CAP PP	RED	ID6
50279002SM	BODY PC	PLUG IR	CAP PP	BLUE	ID6

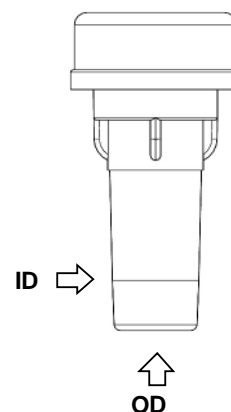

EtO sterilization

CODE	MATERIAL			COLOR	TUBING
50119100SM	BODY RIGID PVC	PLUG IR	CAP PP	NEUTRAL	OD5,5
50119101SM	BODY RIGID PVC	PLUG IR	CAP PP	RED	OD5,5
50119102SM	BODY RIGID PVC	PLUG IR	CAP PP	BLUE	OD5,5
50219100SM	BODY RIGID PVC	PLUG IR	CAP PP	NEUTRAL	ID6
50219101SM	BODY RIGID PVC	PLUG IR	CAP PP	RED	ID6
50219102SM	BODY RIGID PVC	PLUG IR	CAP PP	BLUE	ID6
51019100SM	BODY RIGID PVC	PLUG IR	CAP PP	NEUTRAL	ID4,8
51019101SM	BODY RIGID PVC	PLUG IR	CAP PP	RED	ID4,8
51019102SM	BODY RIGID PVC	PLUG IR	CAP PP	BLUE	ID4,8

INJECTION SITES LATEX FREE

with tube seat and tear cap

Gamma / Beta / EtO / Steam sterilization

CODE	MATERIAL			COLOR	TUBING
54179000SM	BODY PC	PLUG IR	CAP PP	NEUTRAL	OD5,5
54179008SM	BODY PC	PLUG IR	CAP PP	LIGHT BLUE	OD5,5
54379700SM	BODY PC	PLUG IR	CAP PP	NEUTRAL	ID6
54379008SM	BODY PC	PLUG IR	CAP PP	LIGHT BLUE	ID6

EtO sterilization

CODE	MATERIAL			COLOR	TUBING
54119100SM	BODY RIGID PVC	PLUG IR	CAP PP	NEUTRAL	OD5,5
54119108SM	BODY RIGID PVC	PLUG IR	CAP PP	LIGHT BLUE	OD5,5
54319100SM	BODY RIGID PVC	PLUG IR	CAP PP	NEUTRAL	ID6
54319108SM	BODY RIGID PVC	PLUG IR	CAP PP	LIGHT BLUE	ID6
54219100SM	BODY RIGID PVC	PLUG IR	CAP PP	NEUTRAL	ID4,8

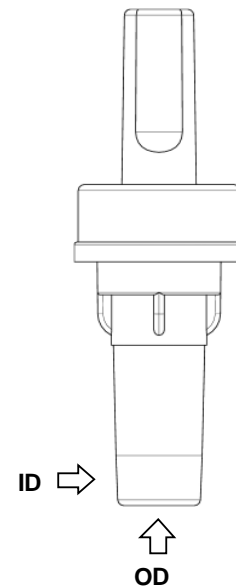

PROTECTIVE CAP FOR INJECTION SITES

Gamma / Beta / EtO sterilization

CODE	MATERIAL	COLOR	INFO
26618200	LLDPE	NEUTRAL	Ø13

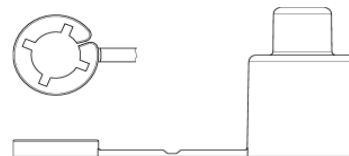



Comef

PILLOWS

for tube OD 6,8, Gambro model



Gamma / Beta / EtO sterilization

CODE	MATERIAL	COLOR	HARDNESS
21317500	SOFT PVC DEHP FREE	NEUTRAL	82Sh A

for tube OD 6,8 with service line, Gambro model

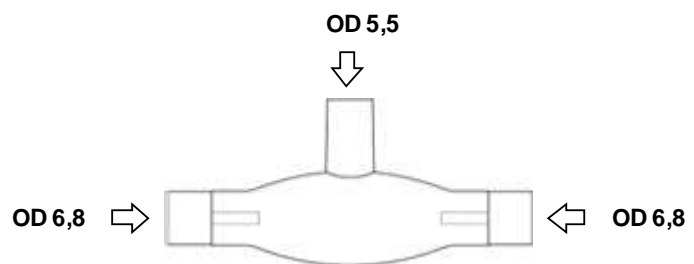

Gamma / Beta / EtO sterilization

CODE	MATERIAL	COLOR	HARDNESS
21307500	SOFT PVC DEHP FREE	NEUTRAL	82Sh A



Comef

ASSEMBLED DRIP CHAMBERS

Ø22/30 - 4 ways cover

EtO sterilization

CODE	MATERIAL	COLOR	INFO	TYPE
47419900SM DEHP FREE A	COVER RIGID PVC	NEUTRAL	OD6,8 3x OD5,5	
	MOULDED FILTER HDPE	NEUTRAL	270µm	
	CHAMBER SOFT PVC	NEUTRAL	OD6,8	GAMBRO
47409900SM DEHP FREE B	COVER RIGID PVC	NEUTRAL	OD6,8 3x OD5,5	
	TUBULAR FILTER PP	NEUTRAL	263µm	
	CHAMBER SOFT PVC	NEUTRAL	OD6,8	GAMBRO
47429900SM DEHP FREE C	COVER RIGID PVC	NEUTRAL	OD6,8 3x OD5,5	
	CHAMBER SOFT PVC	NEUTRAL	OD6,8	GAMBRO

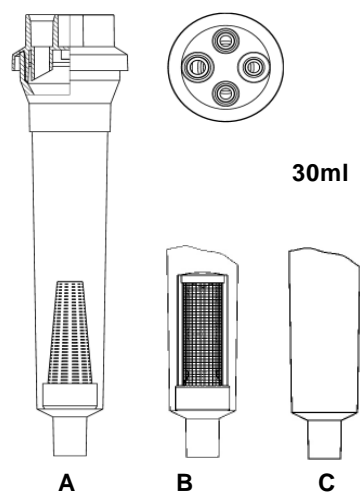

Ø22/30 - 3 ways cover

EtO sterilization

CODE	MATERIAL	COLOR	INFO	TYPE
47439900SM DEHP FREE A	COVER RIGID PVC	NEUTRAL	OD6,8 2x OD5,5	
	MOULDED FILTER HDPE	NEUTRAL	270µm	
	CHAMBER SOFT PVC	NEUTRAL	OD6,8	GAMBRO
47129900SM DEHP FREE B	COVER RIGID PVC	NEUTRAL	OD6,8 2x OD5,5	
	TUBULAR FILTER PP	NEUTRAL	263µm	
	CHAMBER SOFT PVC	NEUTRAL	OD6,8	GAMBRO
47219900SM DEHP FREE C	COVER RIGID PVC	NEUTRAL	OD6,8 2x OD5,5	
	CHAMBER SOFT PVC	NEUTRAL	OD6,8	GAMBRO

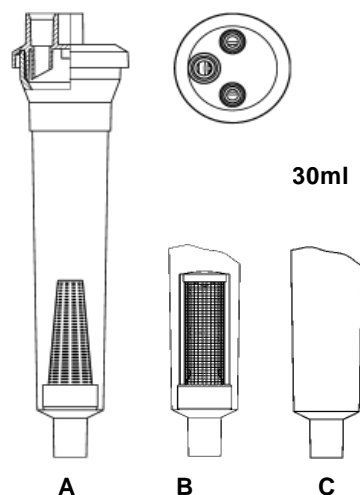

ASSEMBLED DRIP CHAMBERS

Ø20/30 excentric - 3 ways cover

EtO sterilization

CODE	MATERIAL	COLOR	INFO
18449900SM DEHP FREE	COVER RIGID PVC	NEUTRAL	2x OD6,8 OD5,5
	MOULDED FILTER PP	NEUTRAL	270µm
	CHAMBER SOFT PVC	NEUTRAL	OD6,8

30ml



Ø22 - 3 ways cover

Gamma / Beta / EtO sterilization

CODE	MATERIAL	COLOR	INFO	TYPE
59409300SM DEHP FREE	COVER RIGID PVC	NEUTRAL	OD6,8 2x OD5,5	
	MOULDED FILTER PP	NEUTRAL	270µm	
	CHAMBER SOFT PVC	NEUTRAL	OD6,8	SECURA

25ml

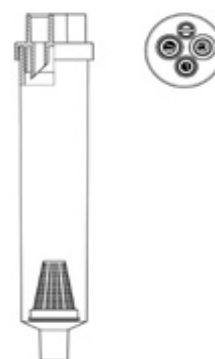

Ø22 - 2 ways cover

Gamma / Beta / EtO sterilization

CODE	MATERIAL	COLOR	INFO	TYPE
59309300SM DEHP FREE	COVER RIGID PVC	NEUTRAL	2x OD6,8	
	CHAMBER SOFT PVC	NEUTRAL	OD5,5	SECURA

25ml

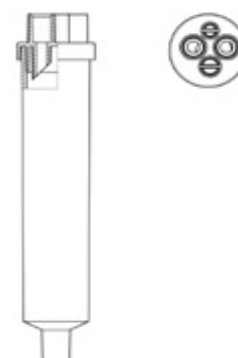

ASSEMBLED DRIP CHAMBERS

Ø27 reverse, Fresenius model - 3 ways cover

Gamma / Beta / EtO sterilization

CODE	MATERIAL	COLOR	INFO
46619200SM	COVER RIGID PVC	NEUTRAL	OD6,8 2x OD5,5
	CHAMBER RIGID PVC	NEUTRAL	OD6,8

EtO sterilization

CODE	MATERIAL	COLOR	INFO
46619100SM	COVER RIGID PVC	NEUTRAL	OD6,8 2x OD5,5
	CHAMBER RIGID PVC	NEUTRAL	OD6,8

25ml

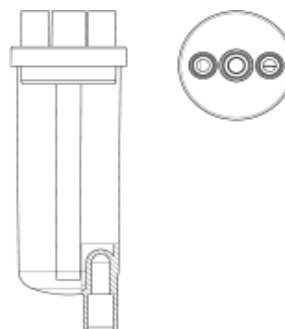

Ø27 reverse, Fresenius model - 2 ways cover

Gamma / Beta / EtO sterilization

CODE	MATERIAL	COLOR	INFO
46609200SM	COVER RIGID PVC	NEUTRAL	OD6,8 OD5,5
	CHAMBER RIGID PVC	NEUTRAL	OD6,8

EtO sterilization

CODE	MATERIAL	COLOR	INFO
46609100SM	COVER RIGID PVC	NEUTRAL	OD6,8 OD5,5
	CHAMBER RIGID PVC	NEUTRAL	OD6,8

25ml

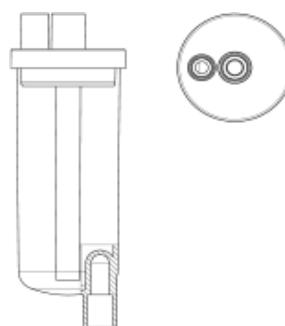

ASSEMBLED INFUSION CHAMBERS

1 way spike

Gamma / Beta / EtO sterilization

CODE	MATERIAL	COLOR	INFO
A002609500 DEHP FREE	CAP LDPE	NEUTRAL	
	SPIKE ABS	WHITE	
	MICRODRIPPER ABS	WHITE	60 DROPS
	CHAMBER SOFT PVC	NEUTRAL	OD4,1 OR ID4,8
	DISK FILTER ABS	WHITE	15µm

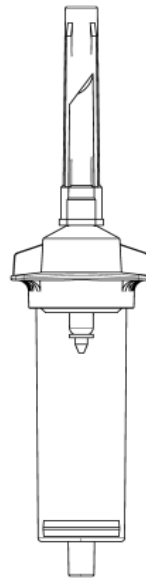

10ml

Gamma / Beta / EtO sterilization

CODE	MATERIAL	COLOR	INFO
32309500SM DEHP FREE	CAP LDPE	NEUTRAL	
	SPIKE ABS	WHITE	20 DROPS
	CHAMBER SOFT PVC	NEUTRAL	OD4,1 OR ID4,8
	DISK FILTER ABS	WHITE	15µm

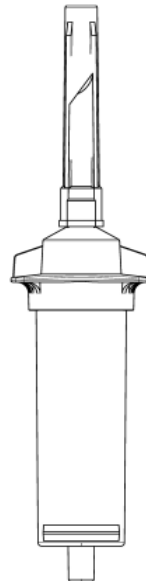

10ml

EtO sterilization

CODE	MATERIAL	COLOR	INFO
32309900SM DEHP FREE	CAP LDPE	NEUTRAL	
	SPIKE RIGID PVC	WHITE	20 DROPS
	CHAMBER SOFT PVC	NEUTRAL	OD4,1 OR ID4,8
	DISK FILTER ABS	WHITE	15µm

ASSEMBLED TRANSFUSION CHAMBERS

1 way spike

Gamma / Beta / EtO sterilization

CODE	MATERIAL	COLOR	INFO
32209700SM DEHP FREE	CAP LDPE	NEUTRAL	
	SPIKE ABS	WHITE	20 DROPS
	CHAMBER SOFT PVC	NEUTRAL	OD4,1 OR ID4,8

EtO sterilization

CODE	MATERIAL	COLOR	INFO
32209500SM DEHP FREE	CAP LDPE	NEUTRAL	
	SPIKE RIGID PVC	WHITE	20 DROPS
	CHAMBER SOFT PVC	NEUTRAL	OD4,1 OR ID4,8

10ml

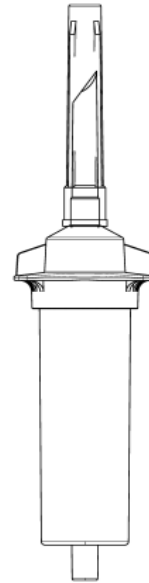

1 way cover

EtO sterilization

CODE	MATERIAL	COLOR	INFO
20229900SM DEHP FREE A	COVER RIGID PVC	NEUTRAL	ID3
	DISK FILTER ABS	WHITE	15µm
	CHAMBER SOFT PVC	NEUTRAL	OD4,1 OR ID4,8
20219900SM DEHP FREE B	COVER RIGID PVC	NEUTRAL	ID3
	CHAMBER SOFT PVC	NEUTRAL	OD4,1 OR ID4,8
20239900SM DEHP FREE C	COVER RIGID PVC	NEUTRAL	OD4,1
	CHAMBER SOFT PVC	NEUTRAL	OD4,1 OR ID4,8

10ml

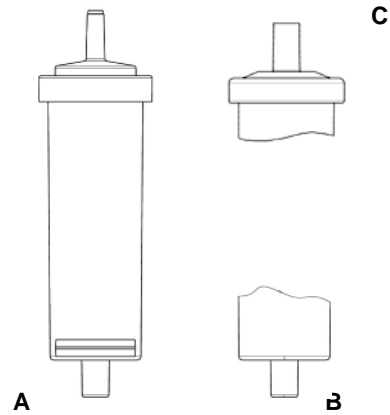

DRIP CHAMBERS

Ø30



Gamma / Beta / EtO sterilization

CODE	MATERIAL	COLOR	OD
352080N0	SOFT PVC DEHP FREE	NEUTRAL	6,8

60ml

Ø22/30



Gamma / Beta / EtO sterilization

CODE	MATERIAL	COLOR	OD	TYPE
240080N0	SOFT PVC DEHP FREE	NEUTRAL	6,8	GAMBRO
C053707500	SOFT PVC DEHP FREE	NEUTRAL	6,8	FRESENIUS

30ml

40ml

DRIP CHAMBERS

Ø20/30 excentric

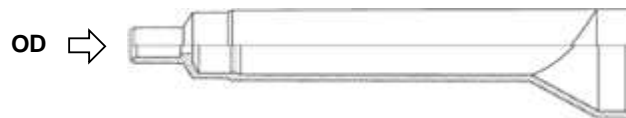

Gamma / Beta / EtO sterilization

CODE	MATERIAL	COLOR	OD
361080N0	SOFT PVC DEHP FREE	NEUTRAL	6,8
36117500	SOFT PVC DEHP FREE	NEUTRAL	5,5

30ml

Ø22



25ml

Gamma / Beta / EtO sterilization

CODE	MATERIAL	COLOR	OD	TYPE	FILTER SEAT
142080N0	SOFT PVC DEHP FREE	NEUTRAL	6,8	SECURA	TUBULAR BLOOD FILTERS
14237500	SOFT PVC DEHP FREE	NEUTRAL	5,5	SECURA	TUBULAR BLOOD FILTERS
142780N0	SOFT PVC DEHP FREE	NEUTRAL	6,8	SECURA	MOULDED BLOOD FILTERS SHORT

DRIP CHAMBERS

Ø22

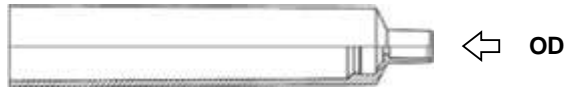

25ml

EtO sterilization

CODE	MATERIAL	COLOR	OD	TYPE
14208100	RIGID PVC	NEUTRAL	6,8	SECURA
14238100	RIGID PVC	NEUTRAL	5,5	SECURA
14228100	RIGID PVC	NEUTRAL	4,1	SECURA

Ø19

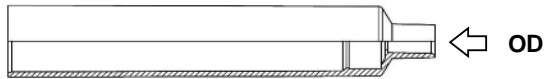

20ml

Gamma / Beta / EtO sterilization

CODE	MATERIAL	COLOR	OD
393080N0	SOFT PVC DEHP FREE	NEUTRAL	6,8
39317500	SOFT PVC DEHP FREE	NEUTRAL	5,5

Ø27 reverse, Fresenius model

Gamma / Beta / EtO sterilization

CODE	MATERIAL	COLOR
46405100	RIGID PVC	NEUTRAL

EtO sterilization

CODE	MATERIAL	COLOR
46408100	RIGID PVC	NEUTRAL

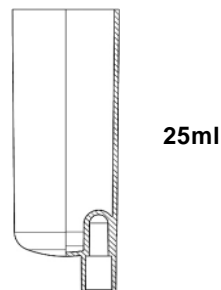

25ml

OD 6,8

DRIP CHAMBERS

short

Gamma / Beta / EtO sterilization

CODE	MATERIAL	COLOR
30117500	SOFT PVC DEHP FREE	NEUTRAL

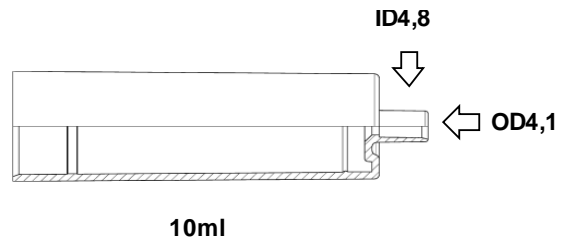

long

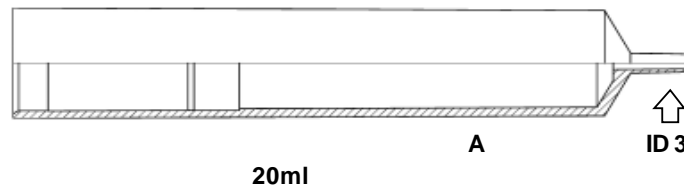

Gamma / Beta / EtO sterilization

CODE	MATERIAL	COLOR	TYPE
08007500	SOFT PVC DEHP FREE	NEUTRAL	A
08107500	SOFT PVC DEHP FREE	NEUTRAL	B
08017500	SOFT PVC DEHP FREE	NEUTRAL	C

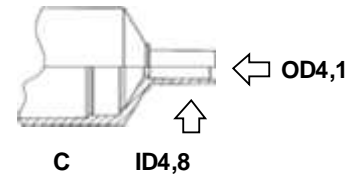
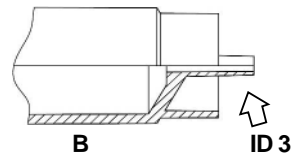

COVERS

Ø30 - 4 ways

Gamma / Beta / EtO sterilization

CODE	MATERIAL	COLOR	TUBING	TYPE
02008400	MABS	NEUTRAL	2x OD6,8 2x OD5,5	A
02018400	MABS	NEUTRAL	OD6,8 3x OD5,5	B
02005100	RIGID PVC	NEUTRAL	2x OD6,8 2x OD5,5	A
02015100	RIGID PVC	NEUTRAL	OD6,8 3x OD5,5	B
C006805100	RIGID PVC	NEUTRAL	OD6,8 3x OD5,5	FRESENIUS

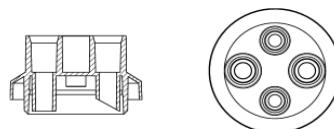

A

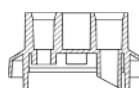

B

EtO sterilization

CODE	MATERIAL	COLOR	TUBING	TYPE
02008100	RIGID PVC	NEUTRAL	2x OD6,8 2x OD5,5	A
02018100	RIGID PVC	NEUTRAL	OD6,8 3x OD5,5	B
C006808100	RIGID PVC	NEUTRAL	OD6,8 3x OD5,5	FRESENIUS

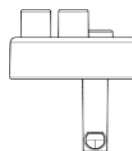

FRESENIUS

Ø30 - 3ways

Gamma / Beta / EtO sterilization

CODE	MATERIAL	COLOR	TUBING	TYPE
02045100	RIGID PVC	NEUTRAL	OD6,8 2x OD5,5	A
02048400	MABS	NEUTRAL	OD6,8 2x OD5,5	A
02055100	RIGID PVC	NEUTRAL	2x OD6,8 OD5,5	A
29308400	MABS	NEUTRAL	OD6,8 2x OD5,5	B
29305100	RIGID PVC	NEUTRAL	OD6,8 2x OD5,5	B
C006815100	RIGID PVC	NEUTRAL	OD6,8 2x OD5,5	FRESENIUS

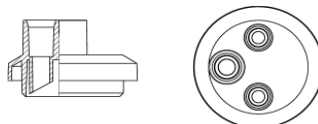

A

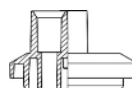

B

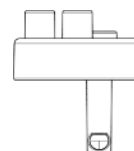

FRESENIUS

COVERS

Ø30 - 3ways

EtO sterilization

CODE	MATERIAL	COLOR	TUBING	TYPE
02048100	RIGID PVC	NEUTRAL	OD6,8 2x OD5,5	A
02058100	RIGID PVC	NEUTRAL	2x OD6,8 OD5,5	A

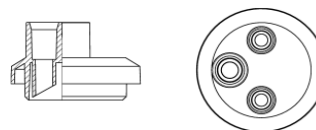

A

CODE	MATERIAL	COLOR	TUBING	TYPE
29308100	RIGID PVC	NEUTRAL	OD6,8 2x OD5,5	B

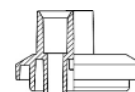

B

CODE	MATERIAL	COLOR	TUBING	TYPE
C006818100	RIGID PVC	NEUTRAL	OD6,8 2x OD5,5	FRESENIUS

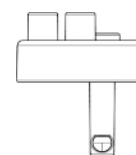

FRESENIUS

Ø30 - 2 ways

Gamma / Beta / EtO sterilization

CODE	MATERIAL	COLOR	TUBING	TYPE
19615100	RIGID PVC	NEUTRAL	2x OD6,8	A
29105100	RIGID PVC	NEUTRAL	OD6,8 OD5,5	B
29115100	RIGID PVC	NEUTRAL	2x OD5,5	B

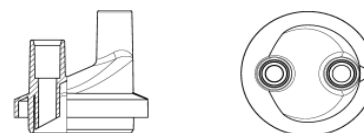

A

EtO sterilization

CODE	MATERIAL	COLOR	TUBING	TYPE
19618100	RIGID PVC	NEUTRAL	2x OD6,8	A
29108100	RIGID PVC	NEUTRAL	OD6,8 OD5,5	B
29118100	RIGID PVC	NEUTRAL	2x OD5,5	B

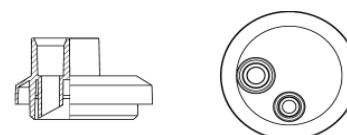

B

COVERS

Ø30 - 1 way

Gamma / Beta / EtO sterilization

CODE	MATERIAL	COLOR	TUBING
01305100	RIGID PVC	NEUTRAL	OD6,8
01315100	RIGID PVC	NEUTRAL	OD5,5

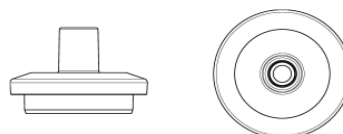

EtO sterilization

CODE	MATERIAL	COLOR	TUBING
01308100	RIGID PVC	NEUTRAL	OD6,8
01318100	RIGID PVC	NEUTRAL	OD5,5

Ø22 - 4 ways

Gamma / Beta / EtO sterilization

CODE	MATERIAL	COLOR	TUBING
19435100	RIGID PVC	NEUTRAL	2x OD6,8 OD5,5 OD4,1
19455100	RIGID PVC	NEUTRAL	2x OD6,8 2x OD4,1

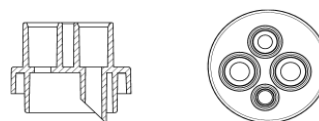

19445100	RIGID PVC	NEUTRAL	2x OD6,8 OD5,5 OD4,1
19465100	RIGID PVC	NEUTRAL	2x OD6,8 2x OD4,1

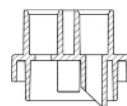

EtO sterilization

CODE	MATERIAL	COLOR	TUBING
19438100	RIGID PVC	NEUTRAL	2x OD6,8 OD5,5 OD4,1
19458100	RIGID PVC	NEUTRAL	2x OD6,8 2x OD4,1

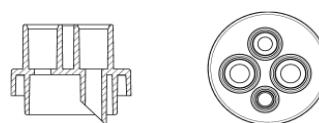

19448100	RIGID PVC	NEUTRAL	2x OD6,8 OD5,5 OD4,1
19468100	RIGID PVC	NEUTRAL	2x OD6,8 2x OD4,1

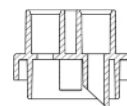

COVERS

Ø22 - 3 ways

Gamma / Beta / EtO sterilization

CODE	MATERIAL	COLOR	TUBING
194A5100	RIGID PVC	NEUTRAL	2x OD6,8 OD5,5
19415100	RIGID PVC	NEUTRAL	OD6,8 OD5,5 OD4,1
19475100	RIGID PVC	NEUTRAL	OD6,8 2x OD4,1

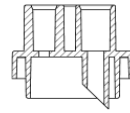

19425100	RIGID PVC	NEUTRAL	OD6,8 OD5,5 OD4,1
19485100	RIGID PVC	NEUTRAL	OD6,8 2x OD5,5

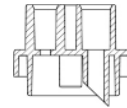

EtO sterilization

CODE	MATERIAL	COLOR	TUBING
194A8100	RIGID PVC	NEUTRAL	2x OD6,8 OD5,5
19418100	RIGID PVC	NEUTRAL	OD6,8 OD5,5 OD4,1
19478100	RIGID PVC	NEUTRAL	OD6,8 2x OD4,1

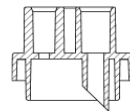

19428100	RIGID PVC	NEUTRAL	OD6,8 OD5,5 OD4,1
19488100	RIGID PVC	NEUTRAL	OD6,8 2x OD5,5

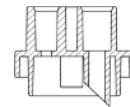

194E8100	RIGID PVC	NEUTRAL	OD6,8 OD5,5 OD4,1
194F8100	RIGID PVC	NEUTRAL	OD6,8 2x OD5,5
194G8100	RIGID PVC	NEUTRAL	OD6,8 2x OD3,6

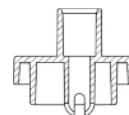

COVERS

Ø22 - 2 ways

Gamma / Beta / EtO sterilization

CODE	MATERIAL	COLOR	TUBING
19405100	RIGID PVC	NEUTRAL	2x OD6,8
19495100	RIGID PVC	NEUTRAL	OD6,8 OD5,5

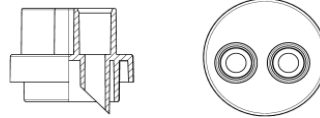

EtO sterilization

CODE	MATERIAL	COLOR	TUBING
19408100	RIGID PVC	NEUTRAL	2x OD6,8
19498100	RIGID PVC	NEUTRAL	OD6,8 OD5,5

Ø19 - 3 ways

Gamma / Beta / EtO sterilization

CODE	MATERIAL	COLOR	TUBING
175080N0	SOFT PVC DEHP FREE	NEUTRAL	OD6,8 2x OD5,5
175180N0	SOFT PVC DEHP FREE	NEUTRAL	OD6,8 2x OD4,1

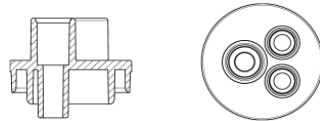

COVERS

Ø19 - 2 ways

Gamma / Beta / EtO sterilization

CODE	MATERIAL	COLOR	TUBING
174080N0	SOFT PVC DEHP FREE	NEUTRAL	OD6,8 OD5,5

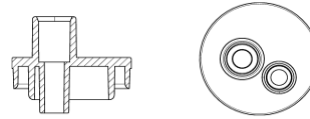

Ø19 - 1 way

Gamma / Beta / EtO sterilization

CODE	MATERIAL	COLOR	TUBING	TYPE
18405100	RIGID PVC	NEUTRAL	ID4,8	A
18415100	RIGID PVC	NEUTRAL	OD5,5	B
18425100	RIGID PVC	NEUTRAL	OD4,1	C

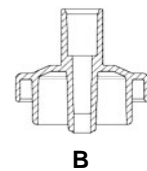
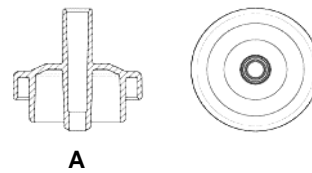

EtO sterilization

CODE	MATERIAL	COLOR	TUBING	TYPE
18408100	RIGID PVC	NEUTRAL	ID4,8	A
18418100	RIGID PVC	NEUTRAL	OD5,5	B
18428100	RIGID PVC	NEUTRAL	OD4,1	C

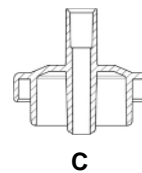

COVERS

Ø27 - 3 ways, Fresenius model

Gamma / Beta / EtO sterilization

CODE	MATERIAL	COLOR	TUBING
46515100	RIGID PVC	NEUTRAL	OD6,8 2x OD5,5

EtO sterilization

CODE	MATERIAL	COLOR	TUBING
46518100	RIGID PVC	NEUTRAL	OD6,8 2x OD5,5

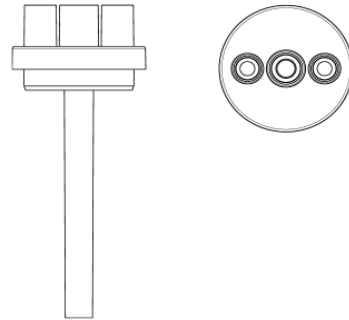

Ø27 - 2 ways, Fresenius model

Gamma / Beta / EtO sterilization

CODE	MATERIAL	COLOR	TUBING
46505100	RIGID PVC	NEUTRAL	OD6,8 OD5,5

EtO sterilization

CODE	MATERIAL	COLOR	TUBING
46508100	RIGID PVC	NEUTRAL	OD6,8 OD5,5

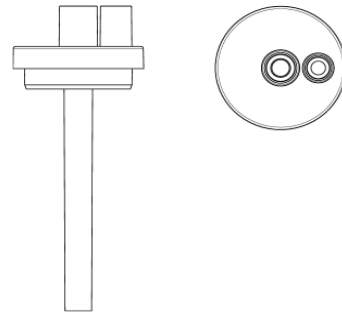

Side flow adaptor for drip chamber's cover

Gamma / Beta / EtO sterilization

CODE	MATERIAL	COLOR
195080N0	SOFT PVC DEHP FREE	NEUTRAL

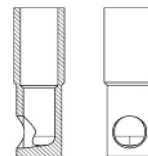

MOULDED BLOOD FILTERS

270 μm

Gamma / Beta / EtO sterilization

CODE	MATERIAL	COLOR
58008300	PP	NEUTRAL

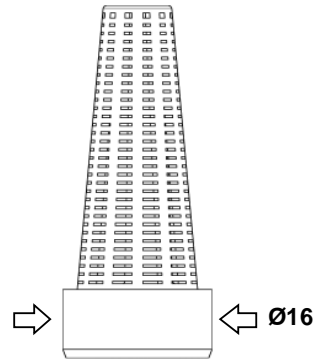

short / 270 μm

Gamma / Beta / EtO sterilization

CODE	MATERIAL	COLOR
C000608300	HDPE	NEUTRAL

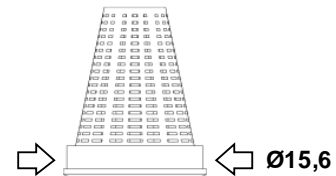

DISK FILTERS

Gamma / Beta / EtO sterilization

CODE	MATERIAL	COLOR	MESH
56308403	SUPPORT ABS	MESH PA	WHITE 15 μm

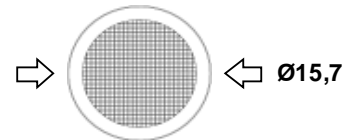

TRANSDUCER PROTECTORS

female Luer lock / tube seat OD5,5

Gamma / Beta / EtO sterilization

CODE	MATERIAL		COLOR
48309300SM	BODY RIGID PVC	MEMBRANE PTFE	NEUTRAL

EtO sterilization

CODE	MATERIAL		COLOR
48309900SM	BODY RIGID PVC	MEMBRANE PTFE	NEUTRAL
48309901SM	BODY RIGID PVC	MEMBRANE PTFE	RED
48309902SM	BODY RIGID PVC	MEMBRANE PTFE	BLUE

FLL, transducer side

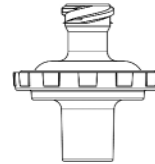

ISO 80369-7



OD 5,5

male Luer / male Luer

Gamma / Beta / EtO sterilization

CODE	MATERIAL		COLOR
48439300SM	BODY RIGID PVC	MEMBRANE PTFE	NEUTRAL

EtO sterilization

CODE	MATERIAL		COLOR
48409900SM	BODY RIGID PVC	MEMBRANE PTFE	NEUTRAL

ML, transducer side

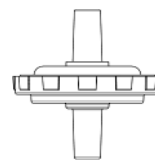

ISO 80369-7

ML

tube seat OD5,5 / tube seat OD5,5

Gamma / Beta / EtO sterilization

CODE	MATERIAL		COLOR
48459300SM	BODY RIGID PVC	MEMBRANE PTFE	NEUTRAL

EtO sterilization

CODE	MATERIAL		COLOR
48459900SM	BODY RIGID PVC	MEMBRANE PTFE	NEUTRAL

OD 5,5, transducer side

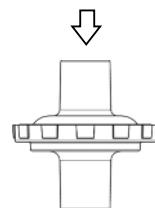

OD 5,5

TRANSDUCER PROTECTORS

female Luer lock / male Luer

Gamma / Beta / EtO sterilization

CODE	MATERIAL		COLOR
48509300SM	BODY RIGID PVC	MEMBRANE PTFE	NEUTRAL

EtO sterilization

CODE	MATERIAL		COLOR
48509900SM	BODY RIGID PVC	MEMBRANE PTFE	NEUTRAL
48509901SM	BODY RIGID PVC	MEMBRANE PTFE	RED
48509902SM	BODY RIGID PVC	MEMBRANE PTFE	BLUE

FLL, transducer side

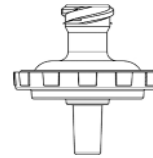

ISO 80369-7

ML

female Luer lock / male Luer lock

Gamma / Beta / EtO sterilization

CODE	MATERIAL		COLOR
48919300SM	BODY RIGID PVC	MEMBRANE PTFE	NEUTRAL

EtO sterilization

CODE	MATERIAL		COLOR
48919900SM	BODY RIGID PVC	MEMBRANE PTFE	NEUTRAL

FLL, transducer side



ISO 80369-7

MLL

male Luer / male Luer lock

Gamma / Beta / EtO sterilization

CODE	MATERIAL		COLOR
49909300SM	BODY RIGID PVC	MEMBRANE PTFE	NEUTRAL

EtO sterilization

CODE	MATERIAL		COLOR
49929900SM	BODY RIGID PVC	MEMBRANE PTFE	NEUTRAL

ML, transducer side

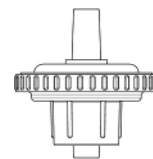

ISO 80369-7

MLL

TRANSDUCER PROTECTORS

with soft snap-off female lock connector /
male Luer lock

Female lock connection,
transducer side

ISO 80369-7

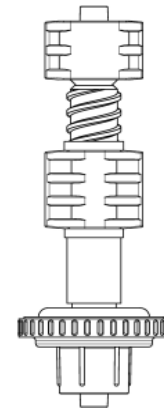

MLL

Gamma / Beta / EtO sterilization

CODE	MATERIAL			COLOR
49969300SM	TP BODY RIGID PVC	MEMBRANE PTFE	CONNECTOR SOFT PVC DEHP FREE	NEUTRAL

EtO sterilization

CODE	MATERIAL			COLOR
49969900SM	TP BODY RIGID PVC	MEMBRANE PTFE	CONNECTOR SOFT PVC DEHP FREE	NEUTRAL

with soft snap-off female lock connector /
male Luer

Female lock connection,
transducer side

ISO 80369-7

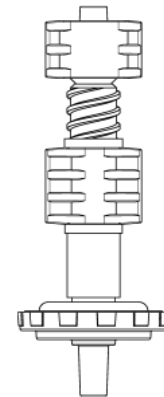

ML

Gamma / Beta / EtO sterilization

CODE	MATERIAL			COLOR
A049975500	TP BODY RIGID PVC	MEMBRANE PTFE	CONNECTOR SOFT PVC DEHP FREE	NEUTRAL

EtO sterilization

CODE	MATERIAL			COLOR
A049979500	TP BODY RIGID PVC	MEMBRANE PTFE	CONNECTOR SOFT PVC DEHP FREE	NEUTRAL

TRANSDUCER PROTECTORS

with soft snap-off female lock connector /
tube seat OD5,5

Female lock connection,
transducer side

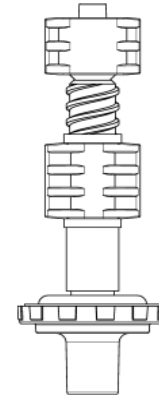

↑
OD 5,5

Gamma / Beta / EtO sterilization

CODE	MATERIAL			COLOR
A049989300	TP BODY RIGID PVC	MEMBRANE PTFE	CONNECTOR SOFT PVC DEHP FREE	NEUTRAL

EtO sterilization

CODE	MATERIAL			COLOR
A049989900	TP BODY RIGID PVC	MEMBRANE PTFE	CONNECTOR SOFT PVC DEHP FREE	NEUTRAL

ACCESSORIES

Recirculating connectors with vented cap

Gamma / Beta / EtO / Steam sterilization

CODE	MATERIAL	COLOR	CAP
42408300	PP	NEUTRAL	OPEN

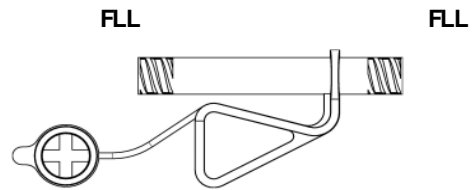

Gamma / Beta / EtO sterilization

CODE	MATERIAL	COLOR	CAP
61008200	HDPE	NEUTRAL	CLOSED

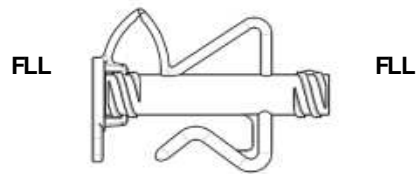

Heparine hooks

Gamma / Beta / EtO / Steam sterilization

CODE	MATERIAL	COLOR	Ø
31308200	HDPE	NEUTRAL	7
31408200	HDPE	NEUTRAL	9

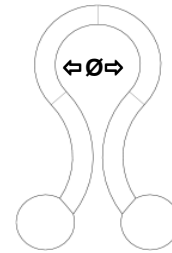

Reduction from OD 6,8 to OD 5,5

Gamma / Beta / EtO sterilization

CODE	MATERIAL	COLOR
10717500	SOFT PVC DEHP FREE	NEUTRAL

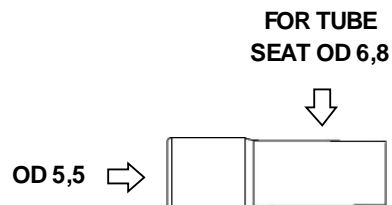

Elbow connector

Gamma / Beta / EtO sterilization

CODE	MATERIAL	COLOR	INFO
351080N0	SOFT PVC DEHP FREE	NEUTRAL	

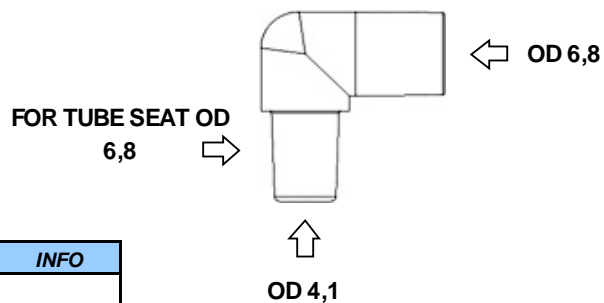

ACCESSORIES

Ultrafiltration connector

Gamma / Beta / EtO sterilization

CODE	MATERIAL	COLOR
27055100	RIGID PVC	NEUTRAL

EtO sterilization

CODE	MATERIAL	COLOR
27058100	RIGID PVC	NEUTRAL

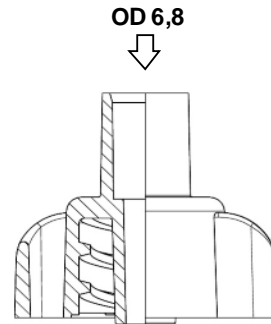

BAG CONNECTORS

with cap and membrane, for tube OD 6,8

Gamma / Beta / EtO sterilization

CODE	MATERIAL	COLOR
35307500	SOFT PVC DEHP FREE	NEUTRAL
35307502	SOFT PVC DEHP FREE	BLUE

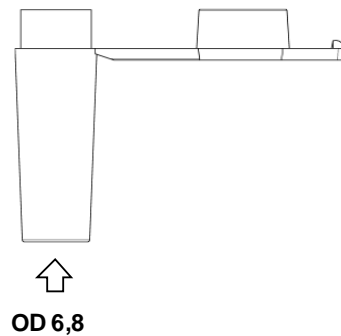

for tube OD 6,8

Gamma / Beta / EtO sterilization

CODE	MATERIAL	COLOR
18007500	SOFT PVC DEHP FREE	NEUTRAL

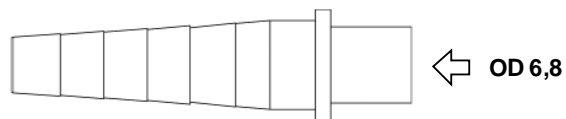

CAPS FOR BAG CONNECTORS

Gamma / Beta / EtO sterilization

CODE	MATERIAL	COLOR
00318200	LDPE	NEUTRAL



CODE	STD. PACKING
00318200	7500
01305100	3500
01308100	3500
01315100	3500
01318100	3500
01845100	10000
01848100	10000
02005100	3000
02008100	3000
02008400	3000
02015100	3000
02018100	3000
02018400	3000
02045100	3000
02048100	3000
02048400	3000
02055100	3000
02058100	3000
02708100	50000
02708403	50000
02808203	45000
08007500	1000
08017500	1200
08107500	1000
08508200	50000
102380N0	20000
103380N0	10000
105080N0	4000
10607500	20000
10717500	40000
10808200	10000
10908200	15000
11408100	13000
11508303	50000
11508308	50000
11808303	50000
13108100	15000
13108101	15000
13108102	15000
13608103	4000
13608403	4000
142080N0	550
14208100	800
14228100	800
14237500	550
14238100	800
142780N0	550
14608100	10000
148380N0	8000
15017500	5000
152080N0	20000
15508100	20000
15608100	15000
15608101	15000
15608102	15000

CODE	STD. PACKING
15708100	17000
15908100	24000
174080N0	6000
175080N0	6000
175180N0	6000
18007500	6000
18405100	9000
18408100	9000
18415100	9000
18418100	9000
18425100	9000
18428100	9000
18449900SM	500
18708403	5000
18808403	5000
18908200	10000
19405100	5000
19408100	5000
19415100	5000
19418100	5000
19425100	5000
19428100	5000
19435100	5000
19438100	5000
19445100	5000
19448100	5000
19455100	5000
19458100	5000
19465100	5000
19468100	5000
19475100	5000
19478100	5000
19485100	5000
19488100	5000
19495100	5000
19498100	5000
194A5100	5000
194A8100	5000
194E8100	5000
194F8100	5000
194G8100	5000
195080N0	30000
19615100	2600
19618100	2600
20219900SM	1500
20229900SM	1500
20239900SM	1500
21307500	1000
21317500	1000
22708403	8000
22808403	8000
240080N0	400
25008103	20000
25818200	9000
26618200	9000

CODE	STD. PACKING
26806701	9000
26806702	9000
26807500	9000
26807501	9000
26807502	9000
26816701	9000
26816702	9000
26817500	9000
26817501	9000
26817502	9000
26827500	9000
26905100	25000
26908100	25000
26908400	25000
26915100	25000
26918100	25000
26925100	25000
26928100	25000
26935100	25000
26938100	25000
26938400	25000
27055100	5000
27058100	5000
27078300	5000
27078301	5000
28609900SM	4000
28659900SM	3800
28679900SM	4000
28709900SM	4000
28719900SM	4000
29105100	3000
29108100	3000
29115100	3000
29118100	3000
29305100	3000
29308100	3000
29308400	3000
30117500	1000
31108200	15000
31228301	5000
31228302	5000
31228303	5000
31308200	40000
31408200	40000
32128100	30000
32128103	30000
32128107	30000
32138100	30000
32158100	30000
32158400	30000
32209500SM	1000
32209700SM	1000
32309500SM	1000
32309900SM	1000
32408200	20000

CODE	STD. PACKING
32408201	20000
32408202	20000
32808200	20000
32808201	20000
32808202	20000
32808203	20000
32918200	14000
32918201	14000
32918202	14000
33508200	14000
33508201	14000
33508202	14000
33618207	30000
33808100	30000
33905100	30000
33908100	30000
34418200	50000
34418403	50000
34505100	20000
34508100	20000
34508400	20000
34515100	20000
34518100	20000
34518400	20000
34525100	20000
34528100	20000
34528400	20000
34555100	20000
34558100	20000
34558400	20000
34608200	20000
34608201	20000
34608202	25000
34709003SM	20000
34709100SM	20000
34709400SM	20000
351080N0	8000
352080N0	500
35307500	7000
35307502	7000
361080N0	375
36117500	375
36608200	30000
36909900SM	4000
37018403	4000
37028403	5000
38928300	3000
38928301	3000
38928302	3000
38928303	3000
38928503	3000
38928913	3000
393080N0	1200
39317500	1200
39808200	50000

CODE	STD. PACKING
39808201	50000
39808202	50000
39808300	50000
39818200	50000
39818201	50000
39818202	50000
39818207	50000
41908100	40000
42408300	8000
42608301	9000
42608302	9000
42608303	9000
42608900	9000
45908100	20000
45918100	20000
45928100	20000
46405100	750
46408100	750
46505100	2250
46508100	2250
46515100	2250
46518100	2250
46609100SM	750
46609200SM	750
46619100SM	750
46619200SM	750
47107500	8000
47117500	8000
47127500	8000
47129900SM	500
47137500	8000
47219900SM	500
47409900SM	500
47419900SM	500
47429900SM	500
47439900SM	500
48309300SM	8000
48309900SM	8000
48309901SM	8000
48309902SM	8000
48409900SM	10000
48439300SM	10000
48459300SM	8000
48459900SM	8000
48509300SM	10000
48509900SM	10000
48509901SM	10000
48509902SM	10000
48919300SM	8000
48919900SM	8000
49508800	1000
49908800	1000
49909300SM	8000
49929900SM	8000
49969300SM	4000

CODE	STD. PACKING
49969900SM	4000
50008800	1000
50019100SM	15000
50019102SM	15000
50079000SM	15000
50079001SM	15000
50079002SM	15000
50108800	1000
50119100SM	15000
50119101SM	15000
50119102SM	15000
50179000SM	15000
50179001SM	15000
50179002SM	15000
50208800	1000
50219100SM	15000
50219101SM	15000
50219102SM	15000
50279000SM	15000
50279001SM	15000
50279002SM	15000
50308800	1000
50608800	1000
50708800	1000
50908800	1000
51008800	1000
51019100SM	15000
51019101SM	15000
51019102SM	15000
54019100SM	10000
54019108SM	10000
54079000SM	10000
54079008SM	10000
54119100SM	10000
54119108SM	10000
54179000SM	10000
54179008SM	10000
54219100SM	10000
54319100SM	10000
54319108SM	10000
54379008SM	10000
54379700SM	10000
56308403	60000
56408403	1250
56508403	10000
58008300	8000
59309300SM	900
59409300SM	900
61008200	8000
70039100SM	5000
70039101SM	5000
70039102SM	5000
70039103SM	5000
70039105SM	5000
70039200SM	5000

CODE	STD. PACKING
70039201SM	5000
70039202SM	5000
70049101SM	5000
70049102SM	5000
70049201SM	5000
70049202SM	5000
73039100SM	4000
73039101SM	4000
73039102SM	4000
73039200SM	4000
73039201SM	4000
73039202SM	4000
73059100SM	4000
73059101SM	4000
73059102SM	4000
73059200SM	4000
73059201SM	4000
73059202SM	4000
73069100SM	4000
73069101SM	4000
73069102SM	4000
73069200SM	4000
73069201SM	4000
73069202SM	4000
73079100SM	4000
73079101SM	4000
73079102SM	4000
73079200SM	4000
73079201SM	4000
73079202SM	4000
73089100SM	4000
73089101SM	4000
73089102SM	4000
73089200SM	4000
73089201SM	4000
73089202SM	4000
A002609500	1000
A036959900	5000
A048209300	10000
A048209301	10000
A048209302	10000
A048209900	10000
A048209901	10000
A048209902	10000
A048229300	10000
A048229301	10000
A048229302	10000
A048229900	10000
A048229901	10000
A048229902	10000
A048239300	10000
A048239900	10000
A049975500	4000
A049979500	4000
A049989300	4000

CODE	STD. PACKING
A049989900	4000
C000608300	15000
C002908100	20000
C002908101	20000
C002908102	20000
C004708300	2500
C004708301	2500
C004708302	2500
C004708303	2500
C006805100	2200
C006808100	2200
C006815100	2200
C006818100	2200
C026955100	25000
C026958100	25000
C026958400	25000
C027307500	8000
C027317500	8000
C027327500	8000
C027337500	8000
C027347500	8000
C033408403	40000
C045415100	25000
C045418100	25000
C053707500	350

Comef srl

via Giovanni XXIII, 174 – 41012 Carpi (Modena) Italy

Phone: (+39) 059 633 611

www.comef.it